

ALUKAP®-SS

High-Spanning Glazing System Installation Guide

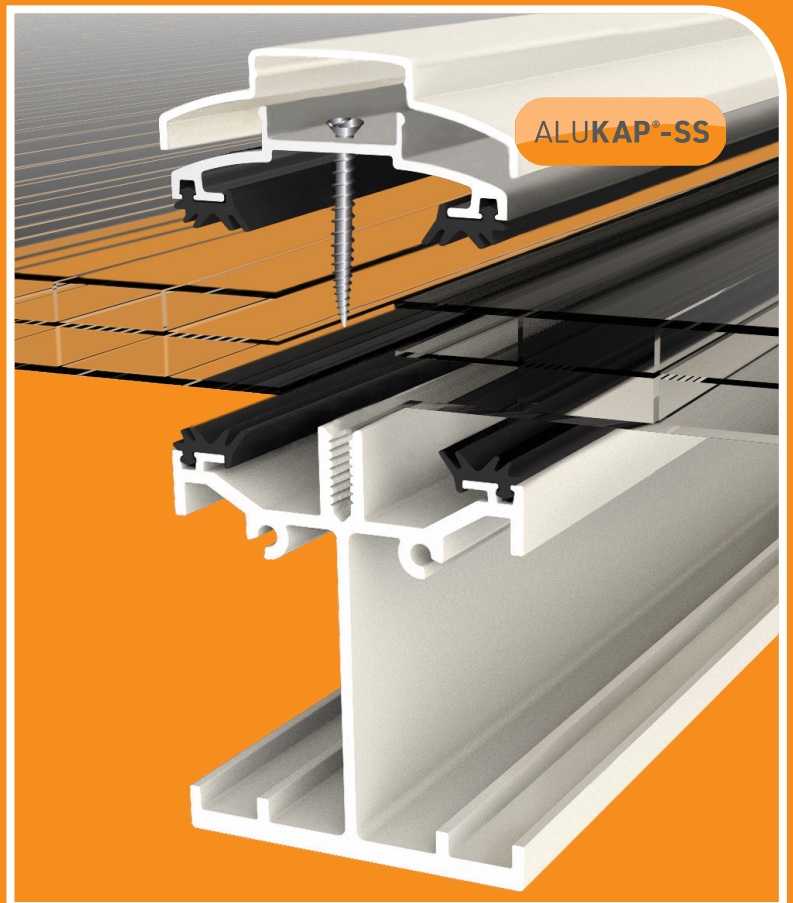

Your ALUKAP®-SS System

Whether you are planning your next project using ALUKAP®-SS, or have just purchased your ALUKAP®-SS system, this *Installation Guide* provides the information you may require to make the installation of your ALUKAP®-SS system straightforward. The system is inherently intuitive, however these guidelines will provide an additional layer of support, no matter how complex your project is.

We Are Here To Support You









We understand that even with comprehensive Installation Guidelines, there can sometimes be a question that you can't find the answer to, so we're here to help you all the way. Visit www.clearamber.com and get in contact with our Help Teams via live chat, phone or email, who will be on hand to assist with any queries you may have.

Index:

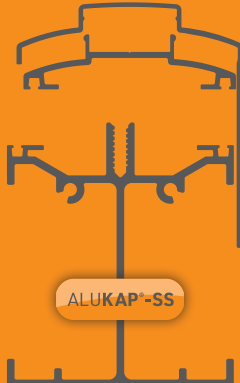
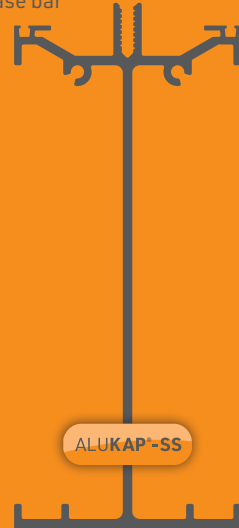
Part 1 : ALUKAP®-SS Bar Parts	3
https://www.clearamber.com/browse/tc-ALUKAP_SS-212/	
ALUKAP®-SS : Bar and Glazing Installation Guide	5
Wall and Eaves Beam	5
New Improved Post and Bracket System	5
L-Cap Bars	6
First Low or High Profile Bars	6
Position the Low and High Profile Bars	7
Measure and Cut all the Required Low or High Profile Bars	7
Measure and Drill the Bolt Fixing Holes	8
Measure and Cut the New Post System	8
Position all the Pre-drilled Span Bars	9
Bolt the Span Bars to the Wall and Eaves Beam	9
Prepare the Base Bars Top Caps	10
Prepare the AXIOME® Sheets Before Installation	10
Fit the ALUKAP®-XR Endstop Bars to the AXIOME® sheets	11
Offer up the First Glazing Panel to the Base Bars	11
Offer up the other Glazing Panels to the Base Bars	12
Prepare and Install the ALUKAP®-XR End Caps	12
Cut the ALUKAP®-SS Top Base Caps	13
Snap fit the ALUKAP®-SS Top Base Caps	13
Fit Top Wall Flashing and Flashing Tape to the back of the roof	14
Fit the Left and Right End Caps	14
Fit the QUADRAFLO® Deep Gutter Brackets	15
Complete ALUKAP®-SS Roof Structure	15

ALUKAP®-SS Bar Parts

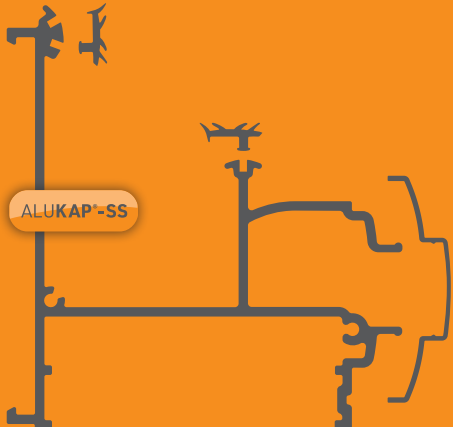
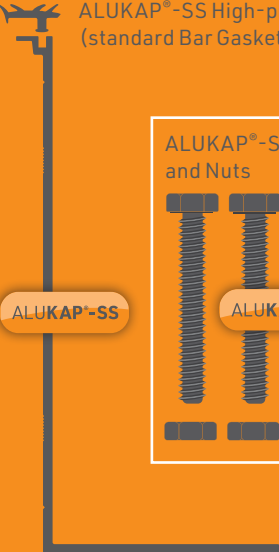
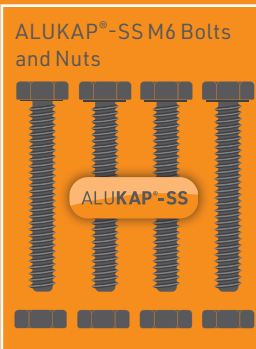
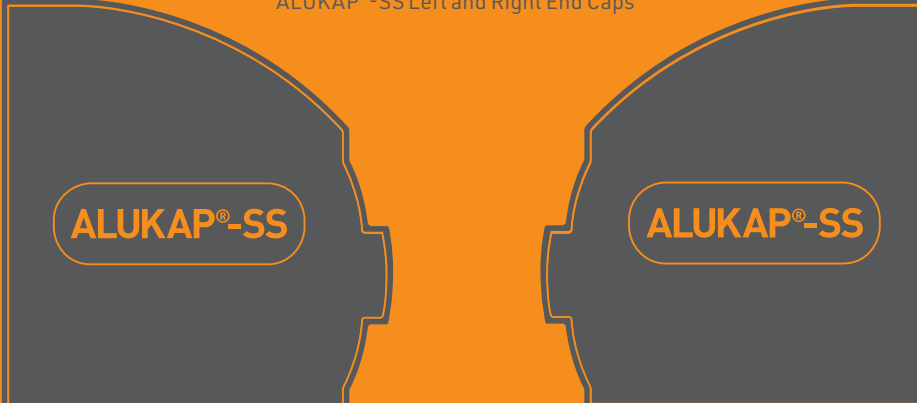
Below is a list of the core ALUKAP®-SS Glazing Bar types available and items that could be supplied with each bar, most of which you will need for your project, depending on the design of your project.

<p>ALUKAP®-SS Wall Bar with the low-profile base bar</p>  <p>ALUKAP®-SS</p>	<p>ALUKAP®-SS 60mm Bar with the low-profile base bar</p>  <p>ALUKAP®-SS</p>	<p>ALUKAP®-SS Gable Bar with the low-profile base bar</p>  <p>ALUKAP®-SS</p>	<p>ALUKAP®-SS High Profile base bar</p>  <p>ALUKAP®-SS</p>
<p>Standard Bar Gaskets and Screws (included)</p>  <p>ALUKAP®-XR 16mm Endstop bar (also in: 6.4mm, 10mm, 25mm, 28mm and 35mm)</p>  <p>ALUKAP®-XR</p> <p>Standard Bar End Cap</p>  <p>ALUKAP®</p>	<p>ALUKAP®-SS Wall & Eaves Beam (standard Bar Gaskets and Bar Top Clip included.)</p>  <p>ALUKAP®-SS</p>	<p>ALUKAP®-SS High-profile L-cap (standard Bar Gaskets included)</p>  <p>ALUKAP®-SS</p> <p>ALUKAP®-SS M6 Bolts and Nuts</p>  <p>ALUKAP®-SS</p>	
<p>ALUKAP®-SS Left and Right End Caps</p>  <p>ALUKAP®-SS</p>		<p>ALUKAP®-SS Low-profile L-cap (standard Bar Gaskets included)</p>  <p>ALUKAP®-SS</p>	

ALUKAP®-SS Bar Parts - continued

ALUKAP®-SS Posts and 2 x Fixing Pins
(2 x long bolts and 2 x short fixing bolts to fit to the ALUKAP®-SS L-Cap included)

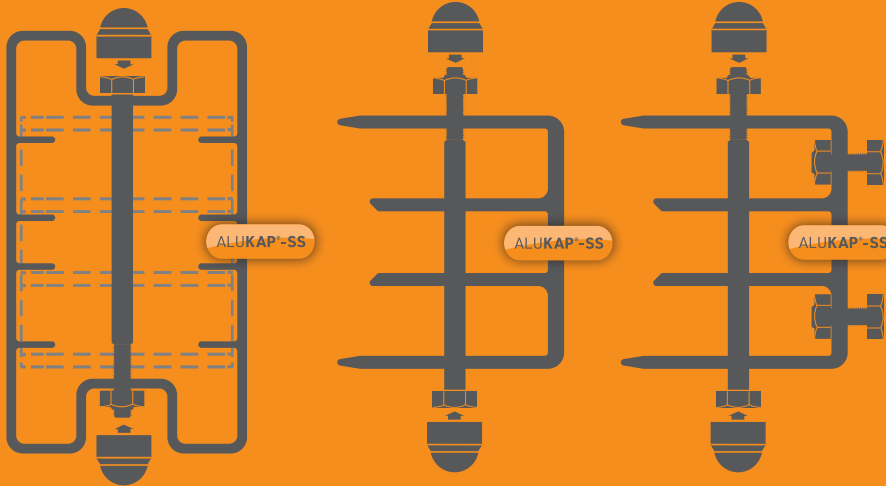

Post Plan

Post Fixing Bracket Side Elevations



Glazing Sheets and Accessories:

AXIOME® 16mm Triplewall Sheets (also in 4mm, 6mm, 10mm, 25mm and 35mm)



AXGARD® Polycarbonate Sheets (also in 4mm, 5mm, 6mm, 8mm, 10mm and 12mm)



Double Glazed Units



Glass



Anti-dust tape

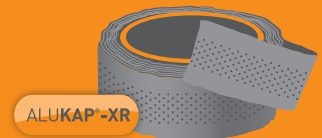

*Optional item

Timber battens/packers for ALUKAP®-SS Gable Bars.



Tools required



Wear protective gloves, glasses and ear protectors where appropriate.



Tape measure and fine toothed bladed Chop Saw



Cordless screwdriver/drill, Philips headed screwdriver, soft rubber headed hammer, a straight edge tool and AXIOME® compatible sealant plus a sealant gun.

ALUKAP®-SS : Bars and Glazing Installation Guide

1 Measure and cut the ALUKAP®-SS Wall and Eaves Beams

IMPORTANT: Wear sufficient protective clothing

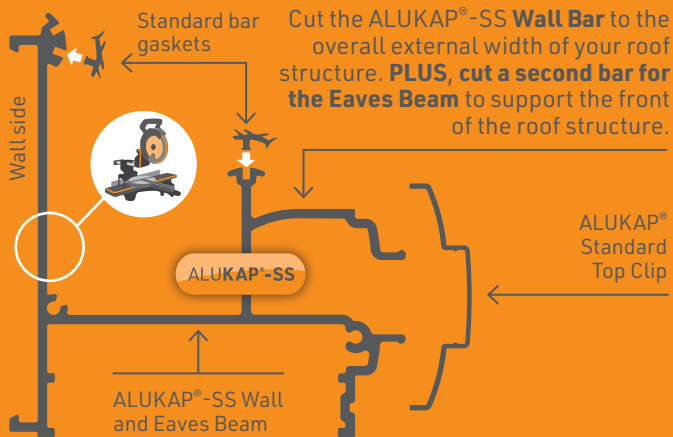

NOTE: FOR HEAVY LOADS OR LONG SPANS: For longer spans and / or heavier loading we recommend the NEW improved post system for additional support below the wall plate.
NOTE: Refer to point 3 below for fitting details.



2 Prepare the ALUKAP®-SS Wall and Eaves Beam

Drill regular holes @250mm apart through the back of the ALUKAP®-SS Wall Plate and **screw/bolt** securely with **suitable fixings from others** suited to the wall (see disclaimer below).

Fit the ALUKAP® bar gaskets on to the base rail and upright rail.

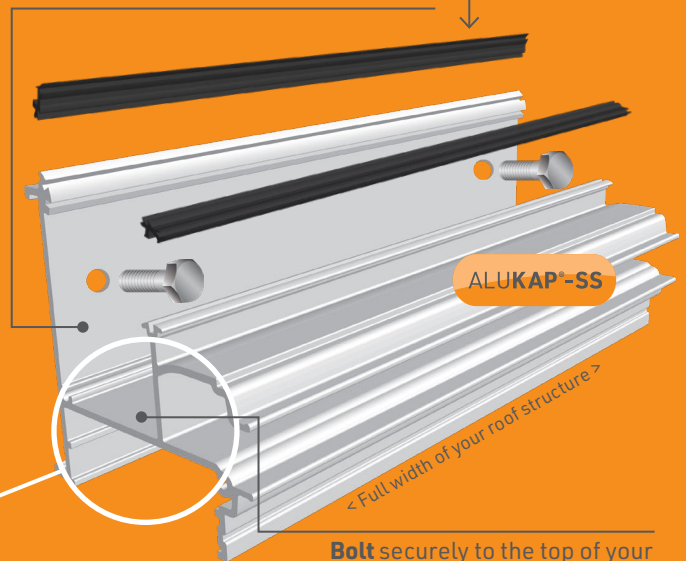

Bolt securely to the top of your window frame or post bracket with suitable stainless steel fixings.

Inasmuch as Clear Amber have no control over the circumstances in which our material may be used, or site specific parameters, we cannot guarantee that any particular results will be achieved. Users should carry out their own tests to determine the suitability of the material for their application. Installers should satisfy themselves that published permissible loadings and bar spacings for ALUKAP®-SS structures, together with any supporting posts, frames, or walls and fixings, are sufficient to provide adequate strength for the intended use and to meet regional loading requirements. **Installers should also obtain their own job-specific structural engineer's report for their individual site.** Samples are readily available to users to test and verify the exact sizes according to their site requirements.

3 Installation of the ALUKAP®-SS New Improved Post and Bracket System

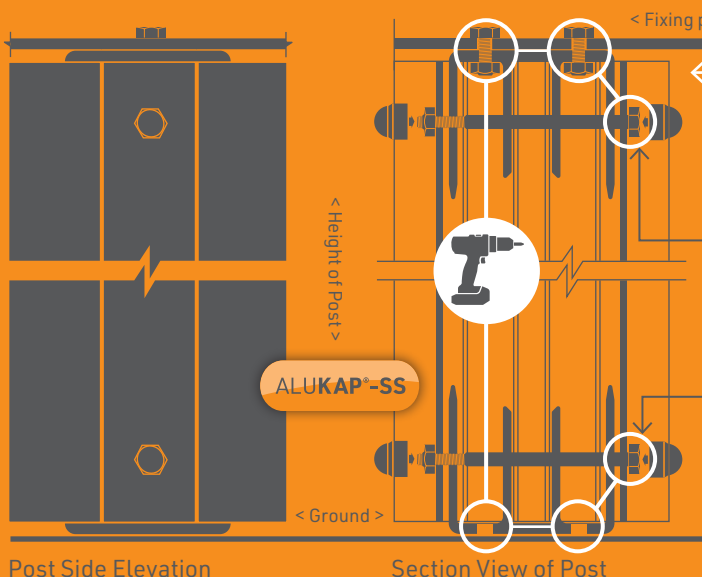

The upper four-pronged bracket are bolted to the underside of the ALUKAP®-SS Eaves Beam / Wall Plate, which then slots in to the top of the ALUKAP®-SS Post.

Drill a hole all the way through the Post and Bracket to accommodate the bolt, securing the post and brackets to the post from uplift. The nut and the head of the bolt should be fixed through the side of the post, so that they are concealed within the recessed side channels.

The lower four-pronged bracket is bolted to the ground / base using suitable fixings supplied by others to create a strong and firm base, the bracket slots inside the post.



4 Measure and cut the ALUKAP®-SS L-Cap Bars

IMPORTANT: Wear sufficient protective clothing

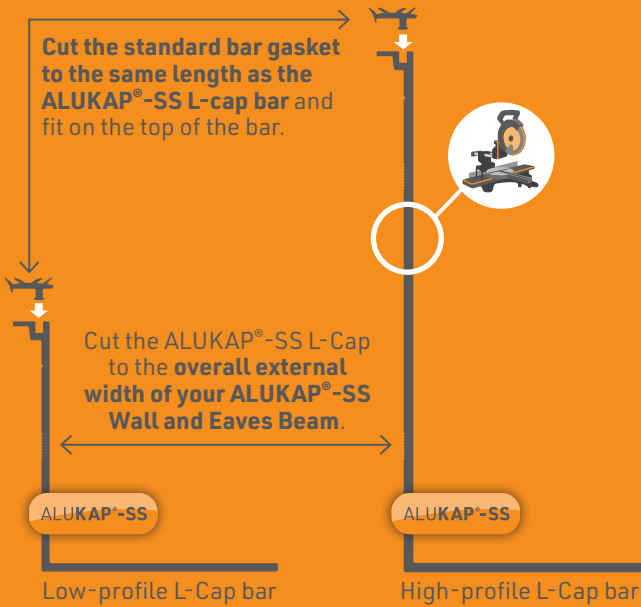

Fit the ALUKAP® bar gaskets into groove of the ALUKAP®-SS L-Cap bar.

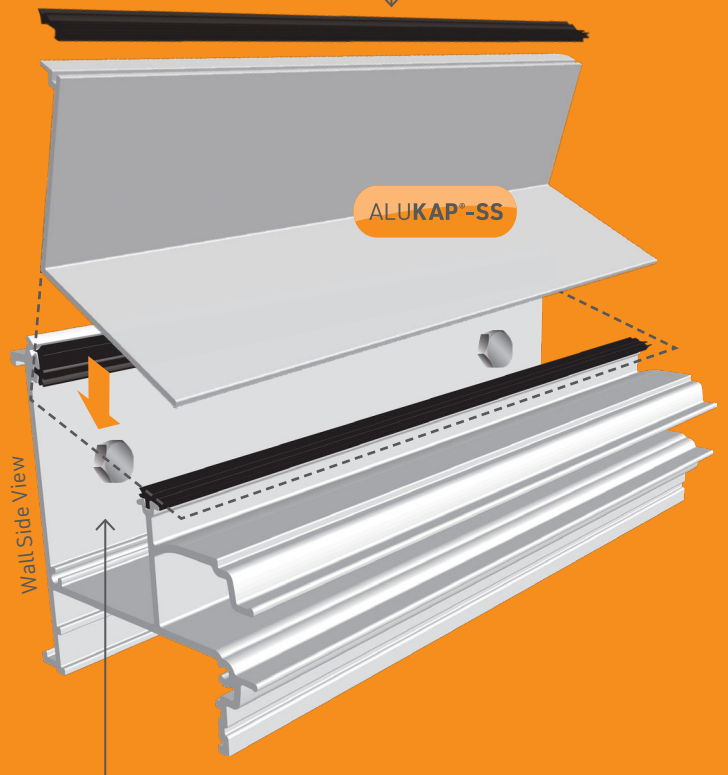

The ALUKAP®-SS L-Cap Bar is placed on top of the two bar gaskets before continuing onto the next stage of the ALUKAP®-SS Low Profile Bar.

5 Measure and CUT THE FIRST ALUKAP®-SS Low or High Profile Bar

NOTE: Measure the length of the roof structure before cutting/preparing the ALUKAP®-SS Low or High Profile base bars.

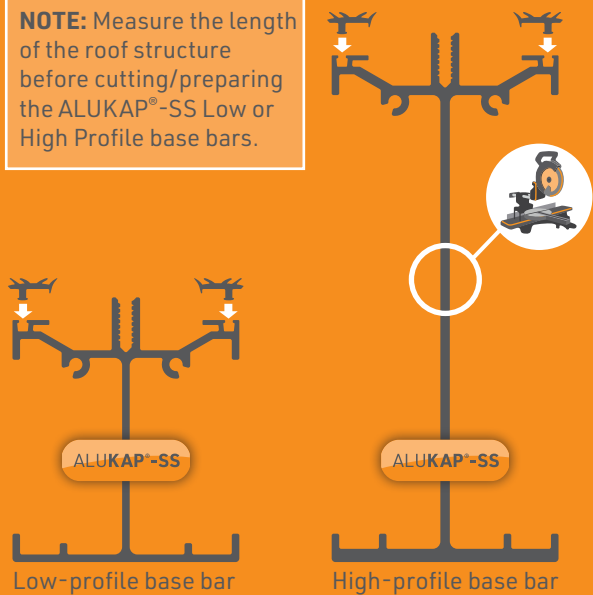

Measure and fit the ALUKAP® bar gaskets into grooves of the ALUKAP®-SS base bar.

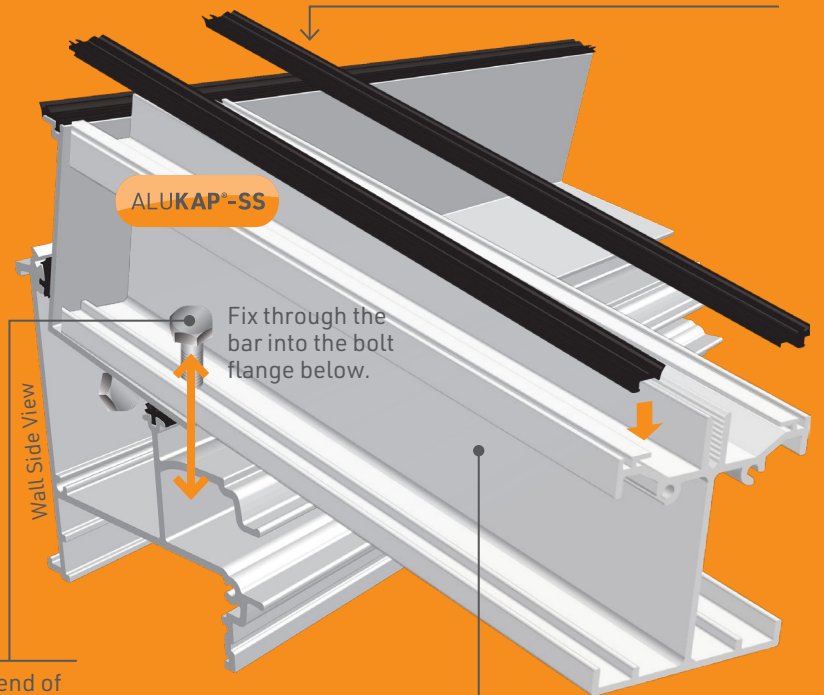

Measure the bolt fixing position on both sides from the end of the ALUKAP®-SS base bar for drilling a 7mm hole through the ALUKAP®-SS span base bar and down through the bolt flange on the ALUKAP®-SS Eaves Beam and Wall Plate. This will vary between 40mm and 70mm depending on the pitch).

Cut the first ALUKAP®-SS Low/High Profile base bar to the correct length to allow it to rest between the TOP and BOTTOM ALUKAP®-SS L-Caps.

6 Measure out the POSITIONS of the ALUKAP®-SS Low or High Profile Bars

Measure out the positions of the ALUKAP®-SS High Span/Low Profile bars for the rest of the roof and mark them on the ALUKAP®-SS Bar L-Cap, **allowing for a minimum of 3mm either side of the glazing** for thermal expansion appropriate to the chosen glazing material.

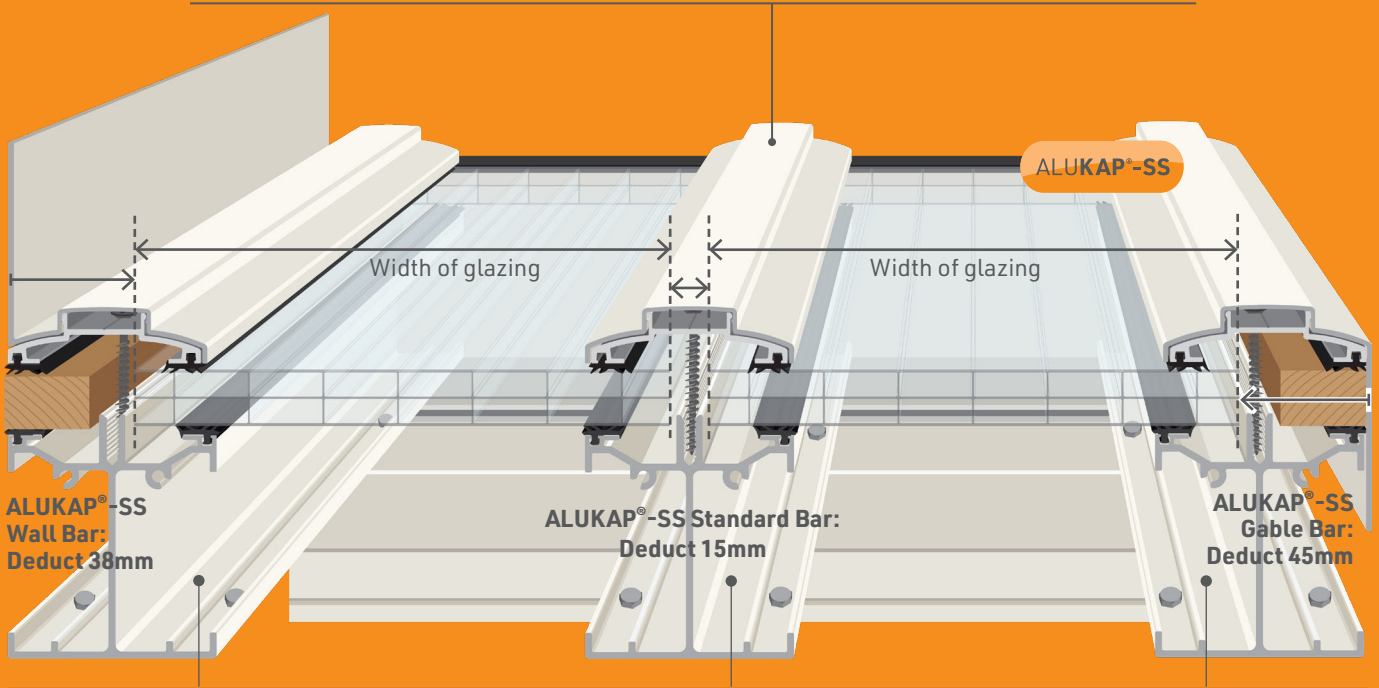

ALUKAP®-SS Glazing Deductions:

Glazing deduction guidelines are shown for the ALUKAP®-SS bar system for the ALUKAP®-SS Wall Bars, ALUKAP®-SS Standard/Centre Bars and ALUKAP®-SS Gable Bars. However these may need to be amended depending on chosen glazing materials and glazing centres.

7 Measure and CUT all the required ALUKAP®-SS Low or High Profile Bars

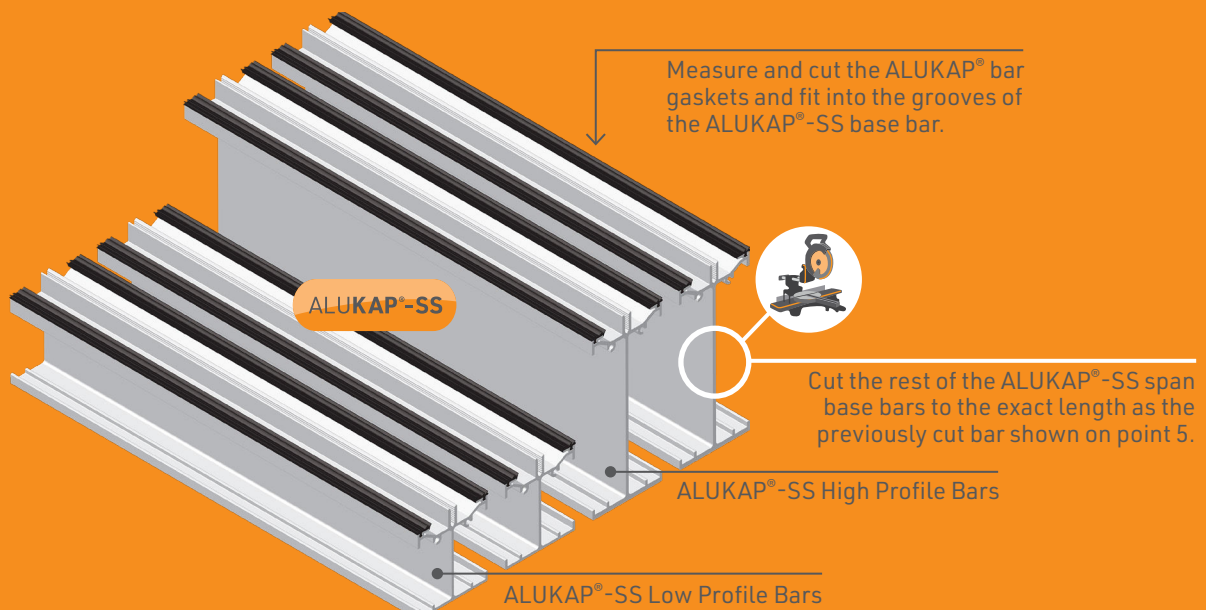

8 MEASURE and DRILL fixing bolt positions on all the pre-cut ALUKAP®-SS Low or High Profile Base Bars

Using measurements taken for the bolt fixing position on the wall side of the first ALUKAP®-SS base bar (from part 5), turn over the remaining ALUKAP®-SS base bars and drill the bolt position using a 7mm drill.

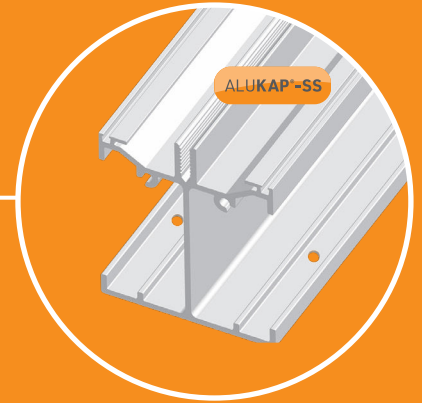
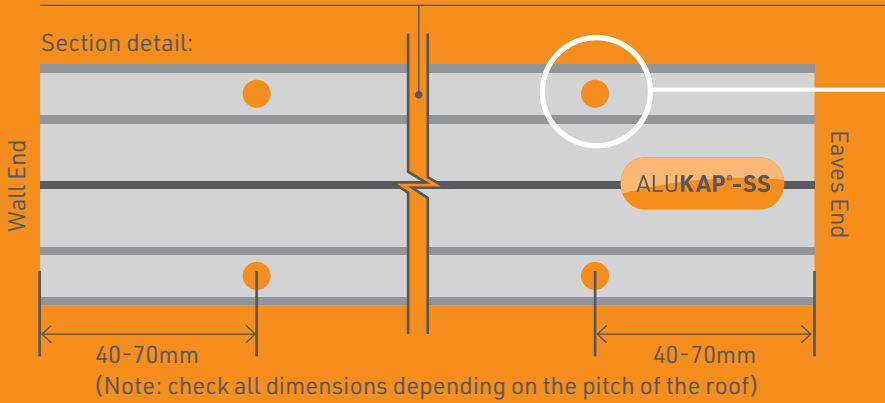

9 Measure and cut the new ALUKAP®-SS Posts to the correct pitch heights

IMPORTANT: Prepare the ground/floor surface to support the weight of the ALUKAP®-SS roof. **Consult with a Structural Engineer** before starting to built the roof structure (refer to page 5).

Turn the ALUKAP®-SS Wall and Eaves Beam around so that the flat surface is facing forward. Refer to the information and diagram below showing how the QUADRAFLO® Deep Guttering system clicks in to the flat frame sided surface.

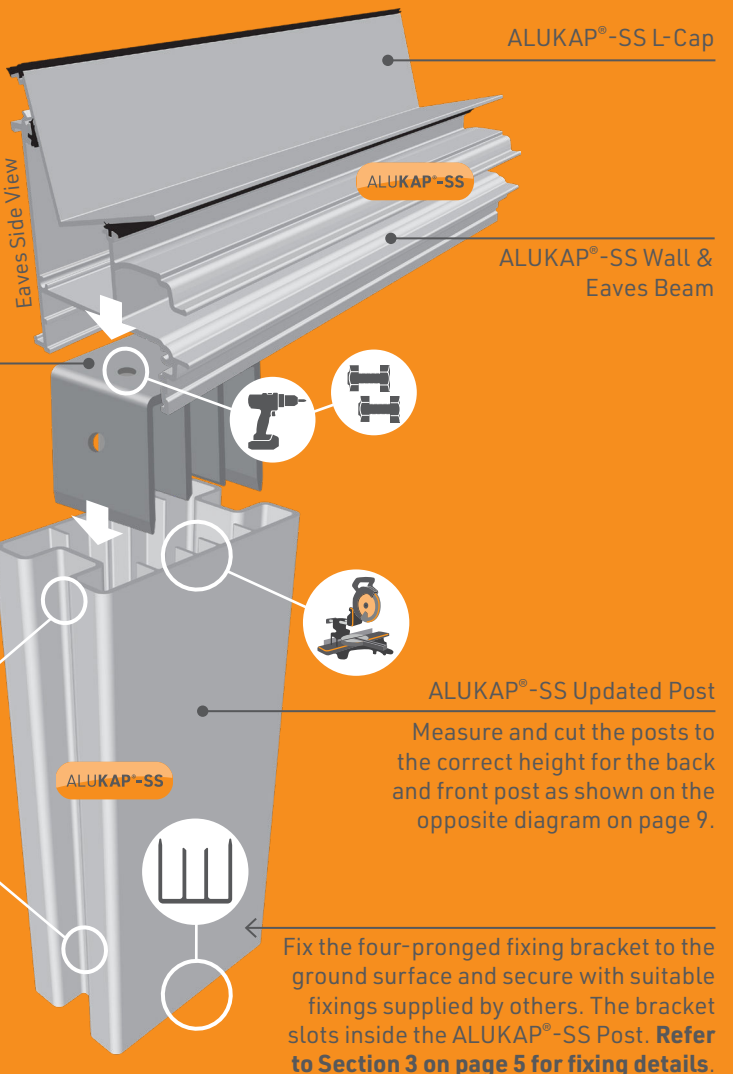
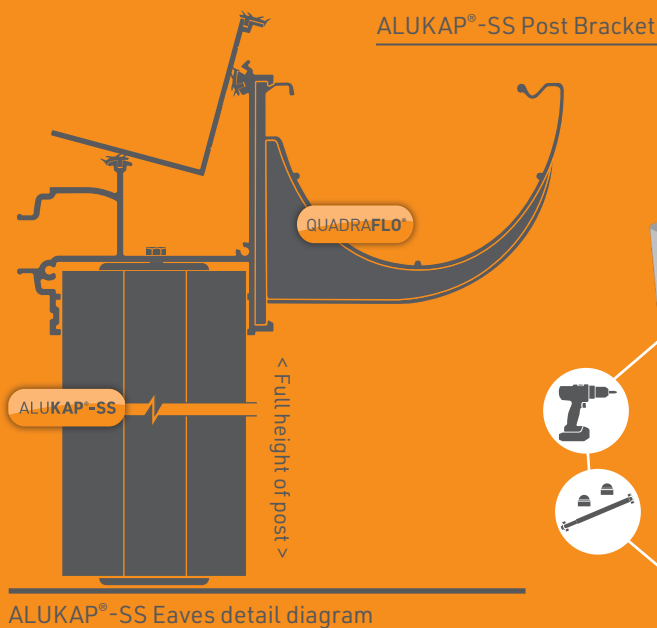

10 POSITION all the ALUKAP®-SS pre-drilled Span Base Bars

Position the pre-drilled ALUKAP®-SS span base bars along the ALUKAP®-SS Wall Plate and Eaves Beam and **drill corresponding 7mm holes through the ALUKAP®-SS Span Bar / L-Cap bars and down through the bolt flange on the ALUKAP®-SS Eaves Beam and Wall Plate.**

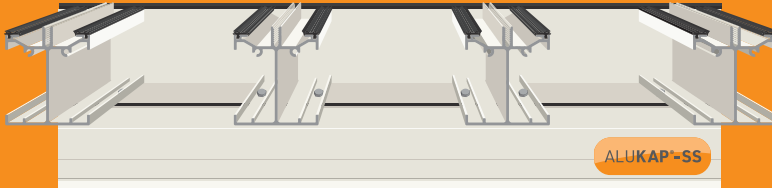

Wall end spacing bars view

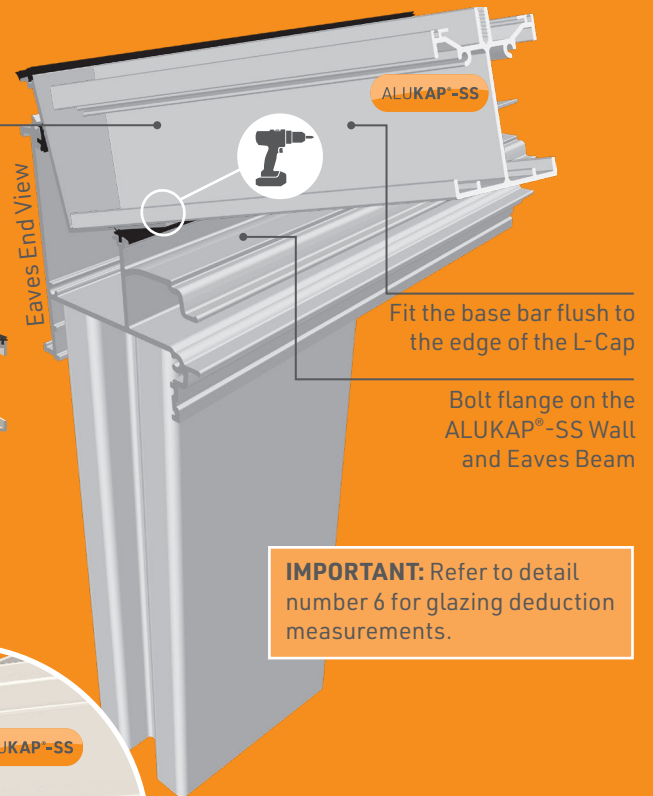

IMPORTANT: Refer to detail number 6 for glazing deduction measurements.

11 BOLT the ALUKAP®-SS Span Base Bars to the ALUKAP®-SS Wall and Eaves Beam

Slot the 6mm M6 bolts through both sides of each bar, top and bottom, and then lightly screw the M6 nuts on to the four M6 bolts for each ALUKAP®-SS span base bar. When you are happy that the positions are all correct, tighten up the nuts.



Fit the bar gaskets to all the ALUKAP®-SS base bars

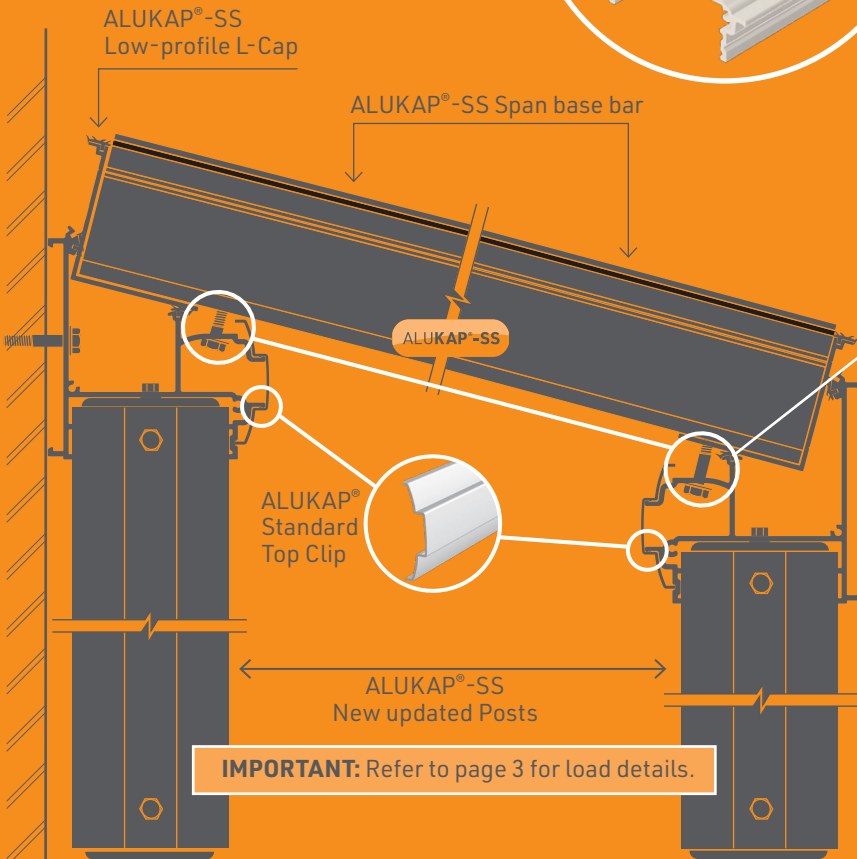
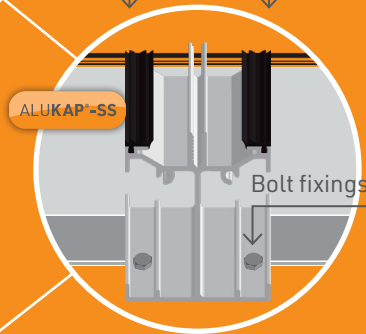

Once all the ALUKAP®-SS base bars are fully fitted snap on the ALUKAP® Standard Top Clips to finish and hide all the fixings in the ALUKAP® Wall & Eaves Beam.



IMPORTANT: Refer to page 3 for load details.

12 Prepare the ALUKAP® Bar Base Top Caps before installation of the glazing panels

Measure and cut the required lengths of the ALUKAP® Top Bar Base Caps allowing for the overhang in to the gutter and the continuation at the wall plate end up to the wall abutment.

Carefully INSERT the thin Standard Bar Gaskets into the grooves on the base of the bar ensuring that the gasket matches the contours of the ALUKAP® Base Bar.

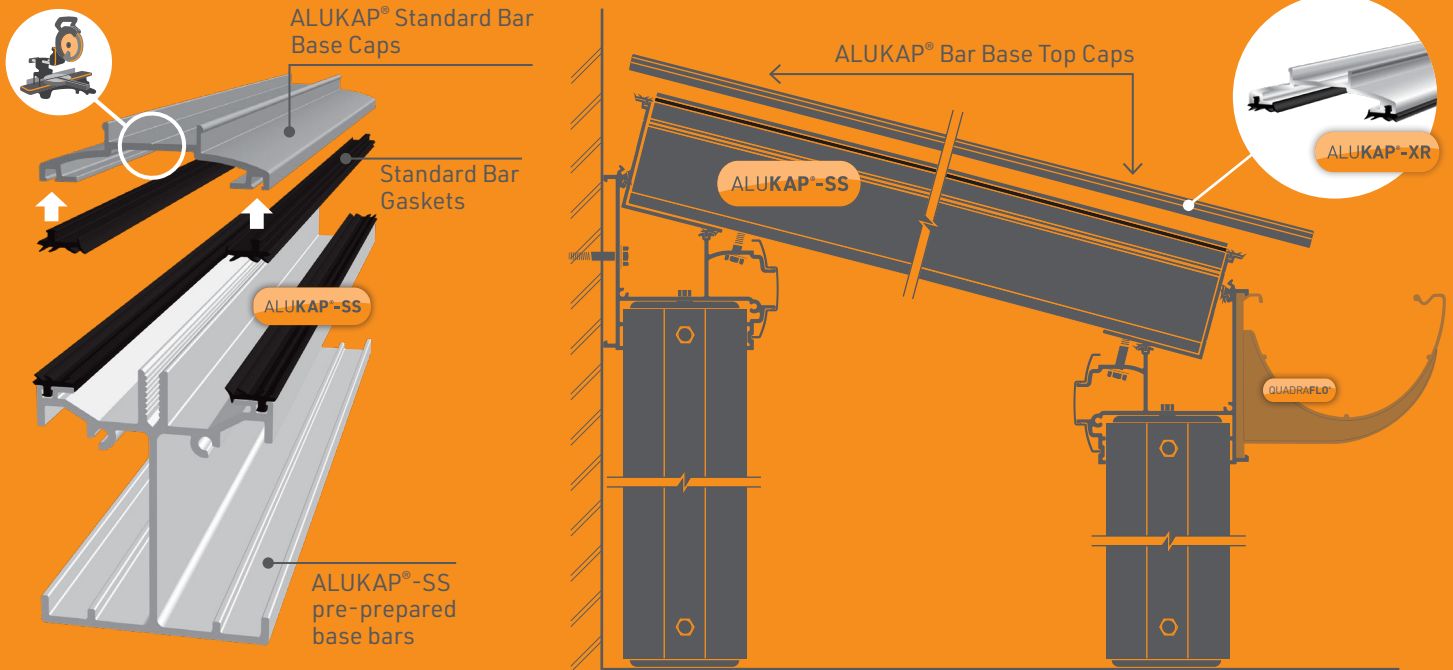

13 Prepare the AXIOME® SHEETS before installation

Where applicable, fit the ALUKAP®-XR End Stop Bar to the edge of the glazing material which works with ALUKAP®-XR glazing bars creating a frame to seal the glazing material and reduce any risk of slippage.

IMPORTANT – Store the AXIOME® sheets in a clean, dry area to prevent moisture getting into the flutes.

There is protective film on both sides of the AXIOME® sheet. The AXIOME® branded tape side is UV protected.

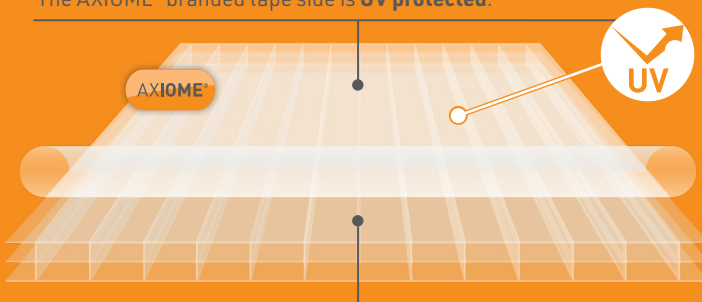

Ensure that you are working in a clean dry area, pull the protective film back approximately 100mm from the open edge on both sides, taking care not to scratch the surface.

14 Apply the ANTI-DUST TAPE to the AXIOME® sheets

IMPORTANT – All adhesives suffer reduced initial bonding strength in cold conditions – avoid applying tape below 5°C.

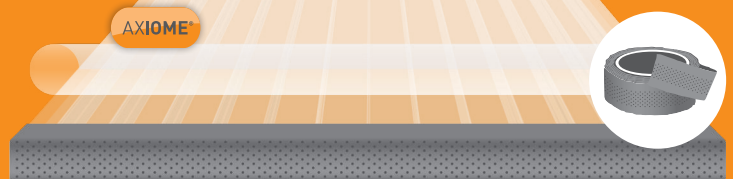

Stick the AXIOME® Anti-dust Breather Tape onto the top surface in a straight line from one side to the other, allowing enough to wrap around and bond to the underside. If it is necessary to join the tape mid-panel, ensure that there is a minimum 25mm overlap.

15 Apply the ALUKAP®XR Endstop bar to the AXIOME® sheets

Cut the Endstop Bar to the width of each AXIOME® Sheet, and push-fit partway ONLY so that the open edge of the Endstop Bar just covers about 10-15mm of the glazing material.



16

Apply the **AXIOME® compatible sealant**

Run a thin, consistent bead of AXIOME® compatible sealant along the edge of the **Endstop bar** and **Anti-dust Breather Tape**.



17

Final stage of fitting the ALUKAP®-XR Endstop Bar

PUSH the **ALUKAP®-XR Endstop bar FULLY into place**, so that the leading edge slides over the bead of sealant, creating a seal that eliminates capillary action.

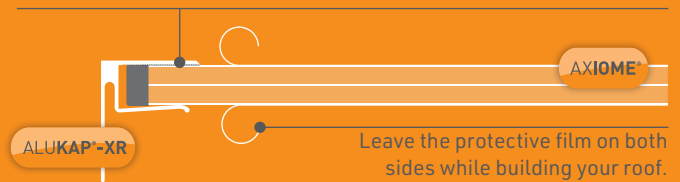

Leave the protective film on both sides while building your roof.

18

Offer up the first glazing panel to the ALUKAP®-SS base bar

On the upper outside edges of the end ALUKAP®-SS Base Bars add a packer the same thickness as the glazing material.

Ensure that ALUKAP®-XR Endstop Bar is fitted to the lower ends of the glazing material.

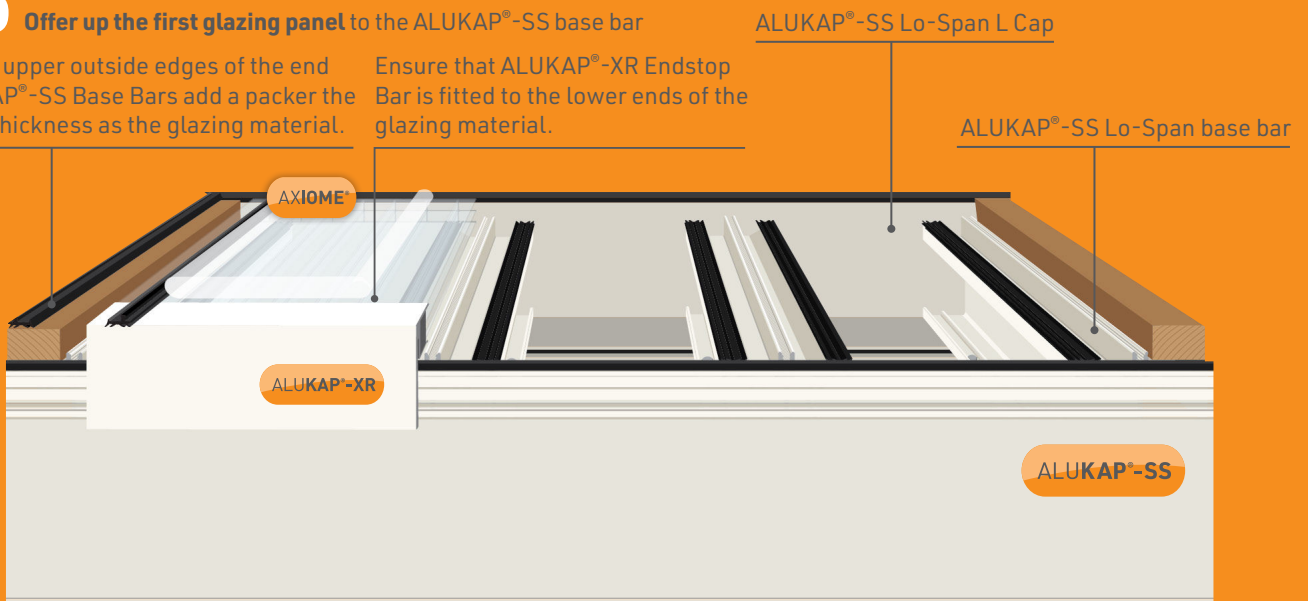

19

Fit the FIRST prepared ALUKAP®-SS Top Base Cap

Refer to point No. 12 for the prepared ALUKAP®-SS Top Base Bar.

Screw fixings in to every pre-drilled hole

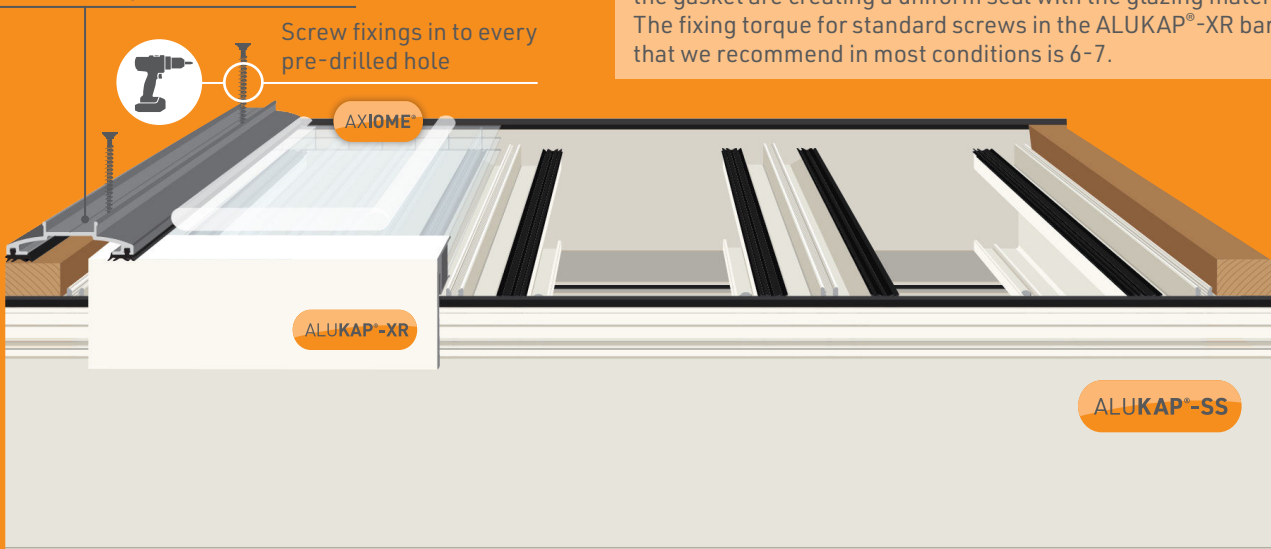

Secure the ALUKAP®-SS Top Bar Base Cap to the first ALUKAP®-SS Base Bar using suitable stainless steel screws, taking care not to over-tighten the screws, but making sure that the gasket are creating a uniform seal with the glazing material. The fixing torque for standard screws in the ALUKAP®-XR bars that we recommend in most conditions is 6-7.

20 Offer up the next glazing panel to the ALUKAP®-SS base bar

Offer up the next glazing panel and repeat the procedure on point No. 19 to fix the next intermediate Alukap®-SS Top Bar Base Cap between the first and second glazing panel. Then continue along the rest of the roof until all glazing panels are secured.

Keep the film on the AXIOME®



21 Repeat and finish fixing the glazing panels on to the roof



22 Prepare and fit the ALUKAP® End cap to each bar

Drill a 2.5mm hole in the ALUKAP®-SS Top Bar Base Cap for the ALUKAP® End cap screw. Secure the ALUKAP® End cap on to the ALUKAP®-SS Top Bar Base Cap. It is normally recommended that this covers the ALUKAP®-XR Endstop Bar, which will be fitted to the glazing material.



23 Carefully cut the ALUKAP®-SS Top Bar Top Caps

Now carefully cut the ALUKAP®-SS Top Bar Top Cap to the accurate length required for a perfect aesthetically pleasing finish. For gable end or wall abutments use the ALUKAP®-SS Gable Bar or Wall Bar Top Cap.

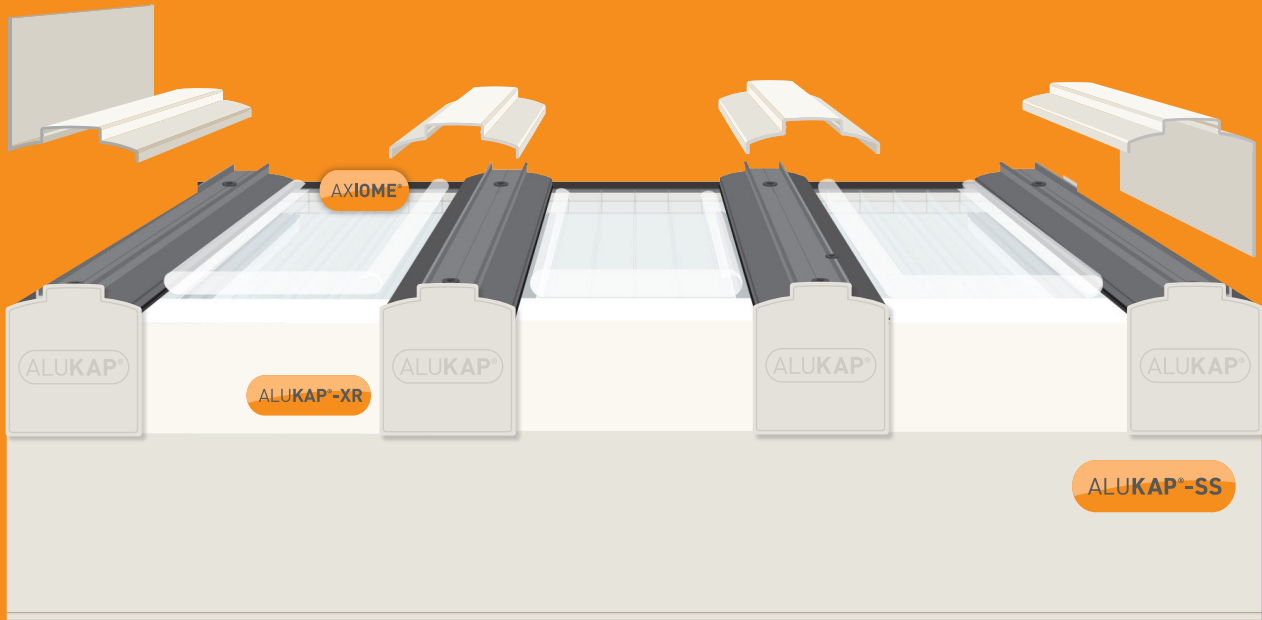

24 Snap fit the ALUKAP®-SS Top Bar Top Caps

Snap the ALUKAP®-SS Top Bar Top Caps on to the Alukap®-SS Top Bar Base Caps along the whole length of the bar. **Use a suitable rubber /plastic headed hammer** for this action and **avoid heavy impact**, to avoid damage to the ALUKAP®-SS bar and the glazing materials.

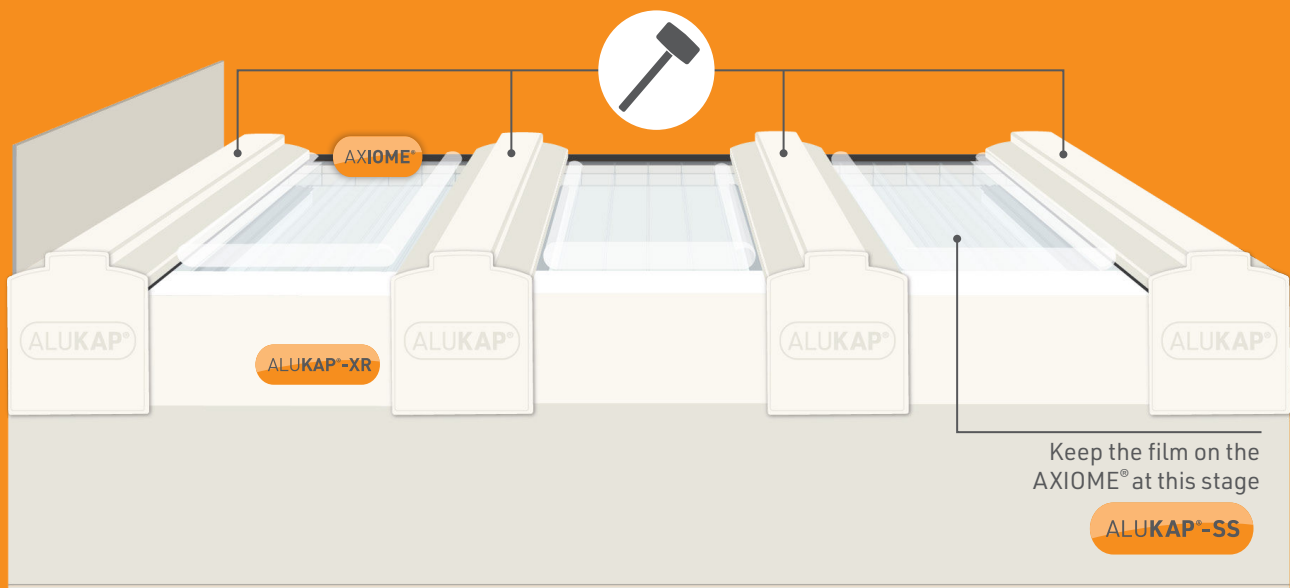

25 Finish of the back of the lean-to roof – fit the **ALUKAP®-SS Top Wall Flashing**

Option One

Fit flashing tape to the back wall and any adjacent wall as required



Place, measure and cut the aluminium **ALUKAP®-SS Top Wall Flashing** and **foam gasket** to match the full width of the roof. Place the Top Wall Flashing onto your roof and mark on the foam gasket where each glazing bar meets Top Wall Flashing. Then cut out a notch at each mark so that the Foam Gasket sits flat on the AXIOME® Sheets and over each Glazing Bar. Alternatively, put pressure to compress the foam gasket to ensure the Foam Gasket Seals against the AXIOME® sheets properly.

Push down the prepared **ALUKAP®-SS Top Wall Flashing** with the prepared gasket in place and fix to the wall using suitable stainless steel screws.

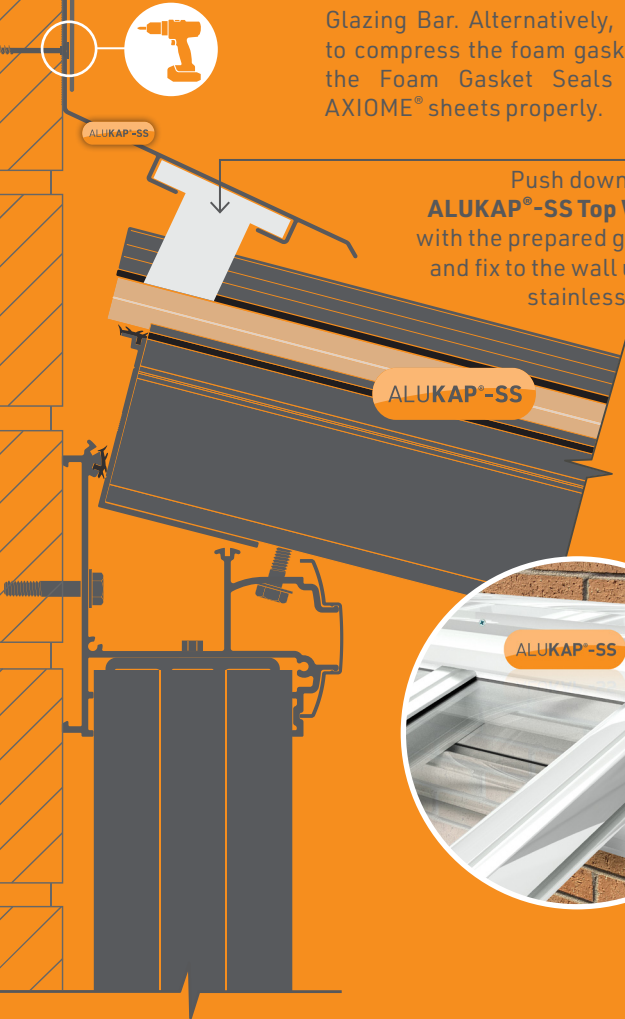

26 Fit **SECURBOND® Flashing Tape** to the back of the roof

Option Two



Mould the **SECURBOND® Flashing Tape** around all the edges of the **ALUKAP®-SS Top Cap bars** to create a waterproof seal at the rear of the roof.

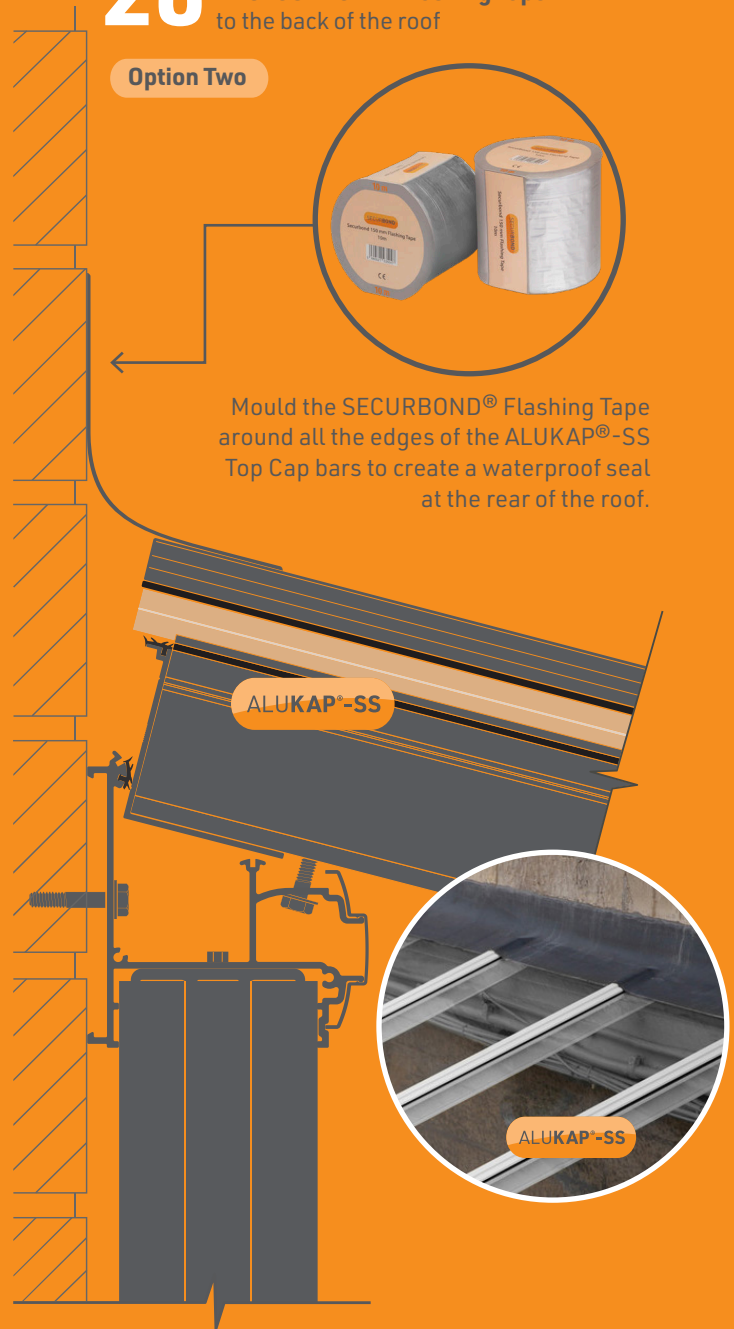

27 Fit the **ALUKAP®-SS Left and Right End caps** to complete the roof structure

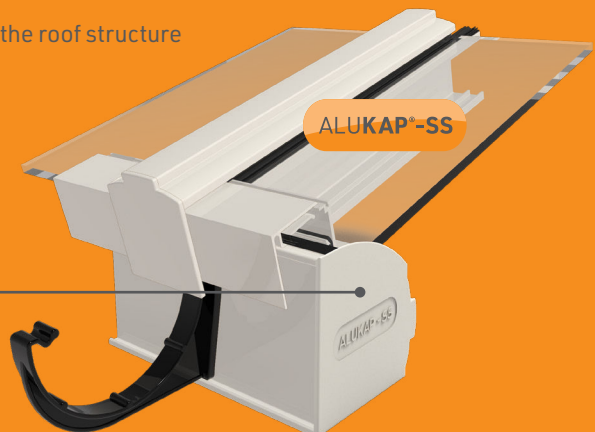

28 Fit the QUADRAFLO® Deep Gutter Bracket

Fix QUADRAFLO® Deep Gutter brackets to the **front face of the ALUKAP®-SS Eaves Beam**, and then fit the remaining desired QUADRAFLO® Deep Gutter and down pipe as required. QUADRAFLO® Deep Style gutter brackets are designed to snap fix in to the front of the ALUKAP®-SS Eaves Beam, and only then require location fixings as desired, saving time on site.

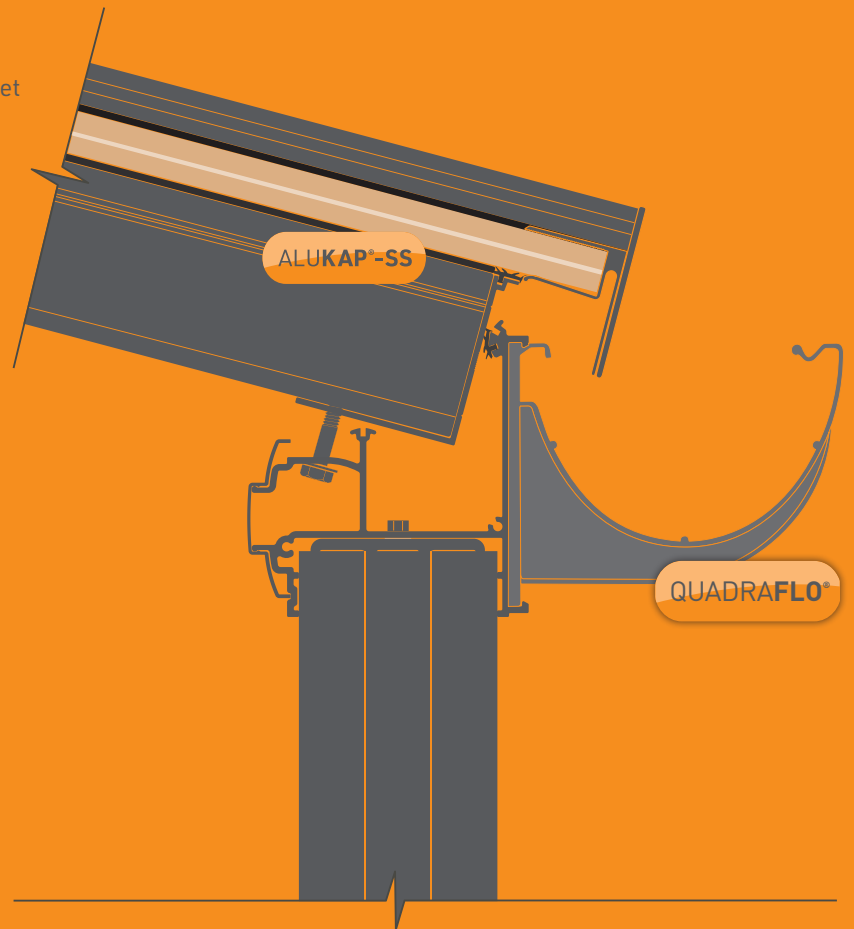

29 Clean the AXIOME® sheets with a soft clean cloth and remove the film to complete the roof



WARNING : REGISTERED DESIGNS & PATENTS

The IP of the designs in this brochure are protected by internationally registered design rights. Many products are also protected with active or pending Patents. Clear Amber will not hesitate to take appropriate legal action if its rights in this respect are infringed.

© Copyright – Clear Amber Group Ltd – May 2023. No part of this publication may be copied, reproduced, scanned, or stored in any electronic database, whether in whole or in part, in any form or by any means, without permission in writing from Clear Amber. Clear Amber will not hesitate to take appropriate legal action if its rights in this respect are infringed.

Inasmuch as Clear Amber have no control over the circumstances in which our material may be used, or site specific parameters, we cannot guarantee that any particular results will be achieved. Users should carry out their own tests to determine the suitability of the material for their application. Installers should satisfy themselves that published permissible loadings and bar spacings for ALUKAP®-SS structures, together with any supporting posts, frames, or walls and fixings, are sufficient to provide adequate strength for the intended use and to meet regional loading requirements. Installers should also obtain their own job-specific structural engineer's report for their individual site. Samples are readily available to users to test and verify the exact sizes according to their site requirements.